

 **Brass Eagle**[®]
PAINTBALL PRODUCTS

Kainmaker[™]

by  **Brass Eagle**[®]



THIS BOOKLET CONTAINS:

- Safety Information
- Warranty Information
- Annotated Diagram
- Operating Instructions
- Select-Fire Instructions
- Battery Life Information
- Trouble-Shooting Guide

MODEL 1451 OWNER'S MANUAL
.68 CALIBER ELECTRONICALLY ACTIVATED
ULTRA-PREMIUM SELECT-FIRE PAINTBALL MARKER

NOT INTENDED FOR SALE TO PERSONS UNDER AGE 18



WARNING: THIS IS NOT A TOY. MISUSE MAY CAUSE SERIOUS INJURY OR DEATH. EYE PROTECTION DESIGNED FOR PAINTBALL USE MUST BE WORN BY THE USER AND ANY PERSON WITHIN RANGE. RECOMMEND AT LEAST 18 YEARS OLD TO PURCHASE, 14 YEARS OLD TO USE WITH ADULT SUPERVISION, OR 10 YEARS OLD TO USE ON PAINTBALL FIELDS MEETING ASTM-STANDARD F1777-97. READ OPERATION MANUAL BEFORE USING.

SPANISH OPERATION MANUAL 00-00
FRENCH OPERATION MANUAL 00-00



WARNING: NEVER SHOOT AT ANYONE WITHOUT PROPER PROTECTIVE EQUIPMENT FOR EYES, EARS, THROAT AND HEAD, WHICH MUST BE WORN AT ALL TIMES. EYE PROTECTION MUST BE DESIGNED SPECIFICALLY FOR PAINTBALL USE. FAILURE TO FOLLOW THESE SAFETY PRECAUTIONS MAY RESULT IN BODILY INJURY INCLUDING BLINDNESS AND DEAFNESS.



This safety alert symbol indicates important safety messages in this manual. When you see this symbol, be alert to the possibility of personal injury and carefully read the message that follows.

Welcome to the Brass Eagle® team and thank you for purchasing this high quality Brass Eagle® paintball marker. The model 1451 Rainmaker™ has an electronically-controlled firing system that represents the leading edge of paintball marker technology.

We at Brass Eagle® stand committed to providing you with the best product and service available. Your Rainmaker™ model is designed and manufactured to provide ease of maintenance with trouble free ultra-premium performance. We ask that you read this manual to obtain the maximum enjoyment of your purchase.



MODEL 1451 OWNER'S
MANUAL
.68 CALIBER ELECTRONICALLY ACTIVATED
ULTRA-PREMIUM SELECT-FIRE
PAINTBALL MARKER
TABLE OF CONTENTS

TOPIC	PAGE
Rules of Safe Paintball Marker Handling	4
Warranty Information	5
Annotated Diagram of Paintball Marker	6-7
Operating Instructions	8-9
Field Strip Instructions	10
Wiring Harness Schematic	10
High-Pressure Hose Moving Procedure	11
Select-Fire Adjustment	12-13
Battery Life	13
Trouble-Shooting Guide	14-16



RULES OF SAFE PAINTBALL MARKER HANDLING

1. Treat every paintball marker as if it were loaded.
2. Never point the paintball marker at anything you don't wish to shoot.
3. Keep the paintball marker on safe until ready to shoot.
4. Keep the barrel plug in the paintball marker's muzzle when not shooting.
5. Always remove gas source before disassembly.
6. Store the paintball marker unloaded and degassed in a locked place.
7. Follow warnings listed on gas source for handling and storage.
8. Never use anything other than .68 caliber paintballs.
9. Do not shoot fragile objects such as windows.
10. Paintballs may cause staining of some porous surfaces such as brick, stucco and wood.
11. Always wear proper eye, face and ear protection designed specifically to stop paintballs.
12. Never shoot a person who is not wearing proper protection.
13. Always measure velocity before playing paintball.
14. Never shoot at velocities in excess of 300 feet per second.

WARRANTY INFORMATION

WARRANTY: LIMITED ONE YEAR WARRANTY

For one year from date of purchase, Brass Eagle® will repair or replace this marker free of charge if defective in material or workmanship. This warranty gives you specific legal rights. You may also have other rights which may vary from state to state. Service is available from authorized Brass Eagle® Service Centers. A list of these is available at Brass Eagle®'s website—**www.brasseagle.com** or by calling Brass Eagle® at **1-877-877-GAME (4263)**. These Service Centers generally offer the quickest service.

If you would rather return your marker to Brass Eagle® you should send it along with your name, address, telephone number, description of problem and proof of purchase (sales slip) to:

Brass Eagle® Inc.
Attn.: Service Dept.
303 Cedar Street
Granby, MO 64844

Do Not return any products via non-trackable services such as regular mail or parcel post. Such products may become lost and Brass Eagle® Inc. will not be responsible for replacement.

PAINTBALL MARKERS OUT OF WARRANTY

Authorized Service Centers will gladly repair any markers out of warranty for a nominal charge to cover parts and labor. Repairs made by Service Centers will usually be faster and less expensive than those sent back to the factory. Any out of warranty Rainmakers returned to Brass Eagle® should include a repair fee of \$225 and must be shipped prepaid. Brass Eagle® will repair or replace the marker with a reconditioned unit of the same model. If payment is not included, you will be billed for the repair fee plus a \$4.00 invoicing fee. Upon receipt of payment, the marker or its replacement will be shipped to you. In the event that the marker include no means of contacting the sender or no payment for repairs is received within 60 days of billing, the ownership of the marker will be forfeited and it will be disposed of at the discretion of Brass Eagle® Inc.

Record the paintball marker's serial number here for your records:

ANNOTATED DIAGRAM:
BRASS EAGLE® MODEL 1451 RAINMAKER™

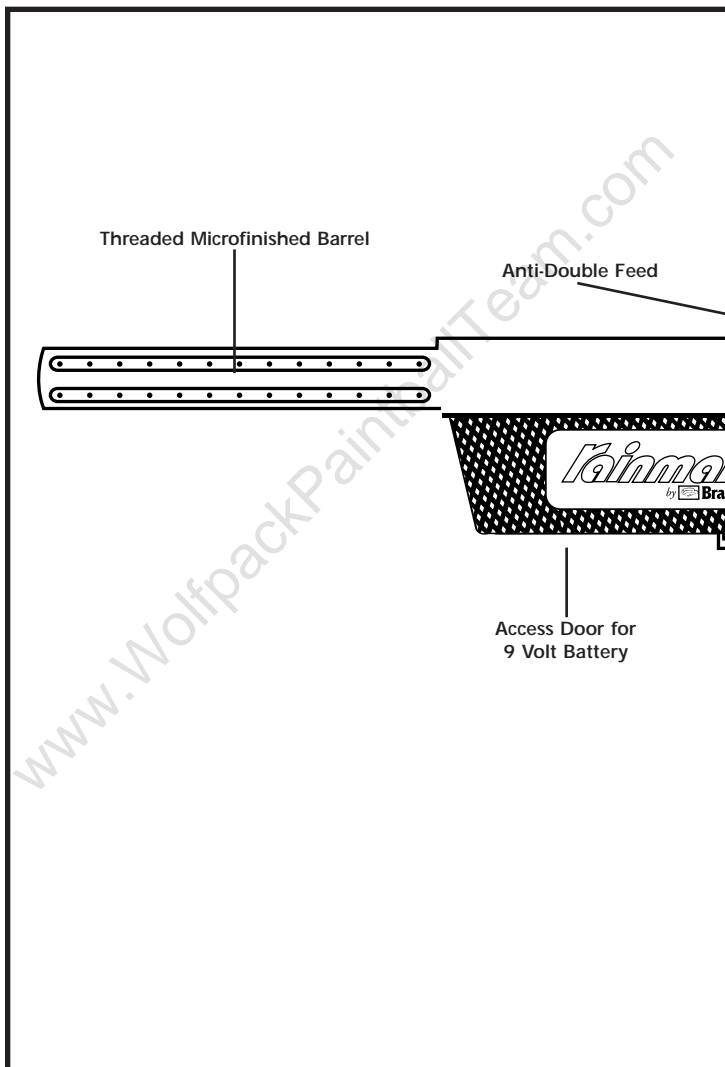

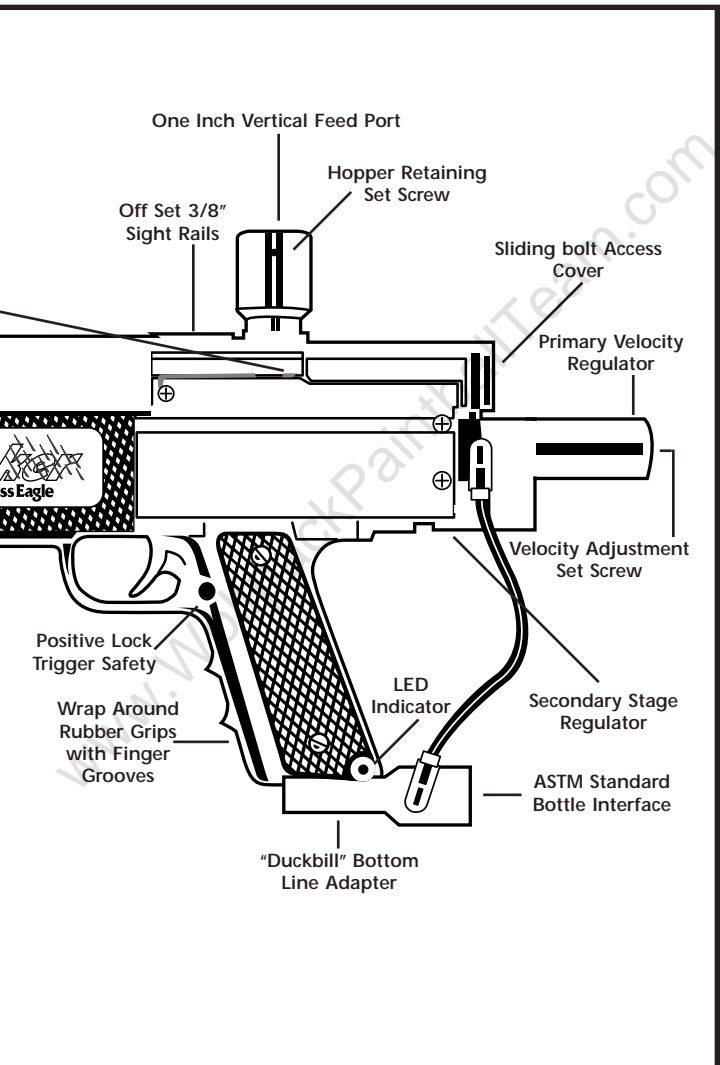

OPERATING INSTRUCTIONS



WARNING: Be sure the paintball marker is always pointed in a safe direction. Read the following operating instructions and **WITHOUT LOADING ANY PAINTBALLS**, proceed several times through the operating steps with your paintball marker (dry fire the paintball marker at a safe target) so that you will be able to operate the Rainmaker properly and safely.

Step 1. PUT ON 'SAFE'. Push safety from left to right; no red band showing. Make sure barrel plug is placed securely in muzzle of marker.

Step 2. INSERT BATTERIES: Insert one 9-volt battery into the battery holder as indicated. Alkaline batteries are required for best performance.

Step 3. ATTACH POWER SOURCE (not included):
The Rainmaker can use CO₂, compressed air or nitrogen.

Using CO₂:

- 1) Point marker downward
- 2) Place bottle valve into constant air adapter
- 3) Screw in bottle without pushing
(allow the threads to draw in the bottle)

Using Compressed Air or Nitrogen:

- 1) Attach per system manufacturers specifications
- 2) Adjust system output to approximately 700 psi



WARNING: Any attempts to use cylinders containing other types of gas could be extremely dangerous. The use of gasses other than CO₂, Nitrogen or Compressed Air could result in an explosion or rupture of the paintball marker, causing serious injury.

NOTE: Dry fire the marker at a safe target without paintballs to ensure the marker is functioning properly.

Step 4. **LOAD PAINTBALLS:**

- 1) Firmly press neck of hopper into vertical feed port.
- 2) Screw in set screw until neck of hopper is held in place (do not over tighten and crush hopper neck).
- 3) Fill hopper with paintballs.

NOTE: Paintballs are gravity fed from hopper to the marker each time the

trigger is pulled. Too rapid a rate of fire, broken balls or too many balls in hopper may cause subsequent balls to break and will adversely affect the paintball marker's accuracy. Use a squeegee to clean inside the paintball marker's barrel. **RECOMMENDED:** Brass Eagle® brand, tournament quality .68 caliber paintballs and Top Brass™ brand premium paintballs. Balls should

be stored in a cool, dry place in sealed plastic bags. Do not subject to freezing, excessive heat, humidity or store in direct sunlight. These conditions may cause ball breakage and/or poor feeding.

Step 5. Make sure everyone within range (200 yards) is properly protected from paintball impacts.

Step 6. Remove barrel plug and take off safe by pressing safety from right side of paintball marker until red band is showing.

Step 7. VERIFY VELOCITY: Verify that the paintball marker's velocity is below 300 feet per second or less if required by playing field. Velocity should be measured with a chronograph prior to playing paintball. Velocity may be adjusted by turning the main regulator adjustment screw (using a 3/16 allen key). Turning the screw counter-clockwise decreases velocity and clockwise increases velocity.

NOTE: This paintball marker has an extremely sensitive velocity adjustment.

Step 8. FIRE: Paintball marker is now ready to fire.



WARNING: Never shoot at anyone without proper protective equipment for eyes which must be worn at all times. Eye protection must be designed specifically for paintball use. Failure to follow these safety precautions may result in bodily injury including blindness and deafness.

FIELD STRIP GUIDE

- Step 1.** Put on SAFE. Push safety from left to right; no red band showing. Make sure barrel plug is placed securely in muzzle of marker.
- Step 2.** BOLT REMOVAL: Note: Marker must have gas pressure to set bolt in proper position for removal. Tilt paintball marker down (prevents balls from exiting rear of paintball marker when bolt is removed). Remove bolt cover by sliding from rear of paintball marker. Lift bolt out by recessed grooves located on sides of bolt. (See diagram A)

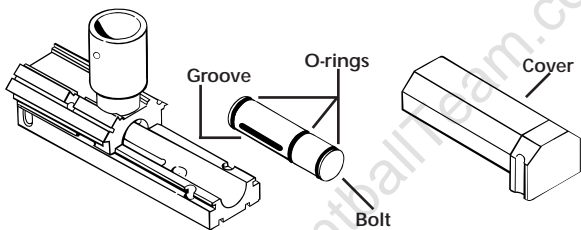

BOLT CLEANING & REASSEMBLY

Clean and lubricate bolt with a silicone based or other lubricant which does not corrode rubber parts such as the bolts o-rings. Follow above steps in reverse to reassemble.

WIRING HARNESS SCHEMATIC

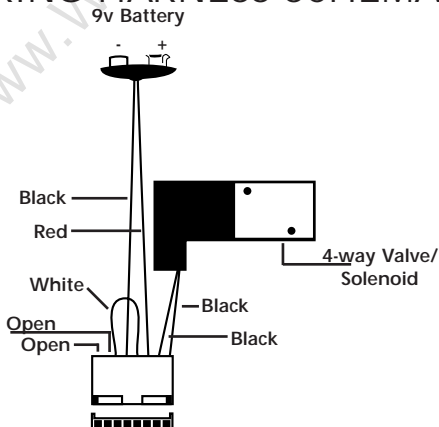

MOVING HIGH-PRESSURE HOSE FROM LEFT TO RIGHT SIDE

- Step 1.** Make sure gas supply is removed from paintball marker!
- Step 2.** Put on SAFE. Push safety from left to right; no red band showing. make sure barrel plug is placed securely in muzzle of paintball marker.
- Step 3.** Using 1/8" allen key, remove two bottom-line retaining screws.
- Step 4.** Using open end wrench, also remove elbow from regulator housing.
- Step 5.** Using 3/16" allen key remove plug from regulator housing.
- Step 6.** Reverse above procedures using teflon tape or pipe thread sealer on threaded joints. The elbow on the Bottom-Line Adapter will need to be readjusted using the open-end wrench to orient properly.

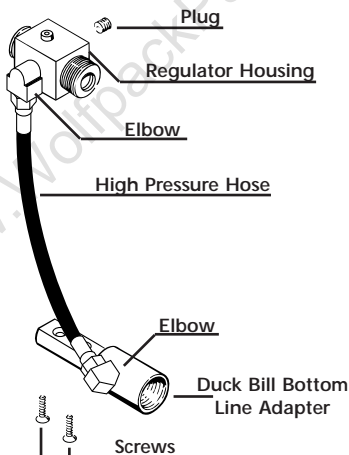

SELECT-FIRE ADJUSTMENTS

Your Rainmaker is capable of firing paintballs in three modes: fully automatic, 3-shot burst, and semi-automatic. To select one of these modes you must first remove the grip screws (2) holding the left side of the rubber grip to the frame as shown and fold back the panel.

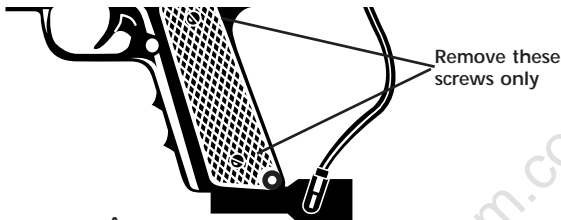

Diagram A

Now you can select the mode by using a small object such as a small screwdriver to move the 3-position switch as shown.

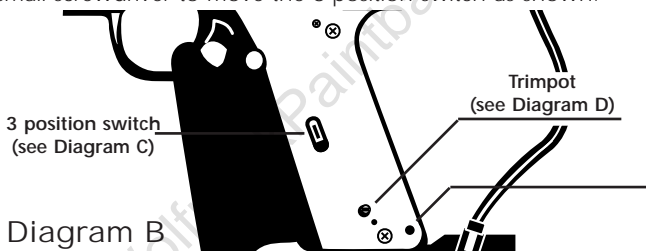

Diagram B

The top-most position is fully automatic. One pull of the trigger will produce a continuous rate of fire until the trigger is let go. The middle position is semi-automatic. One pull of the trigger will produce one firing of the paintball marker. The bottom position is 3 shot burst. One pull of the trigger will produce a rate of 3 continuous shots.

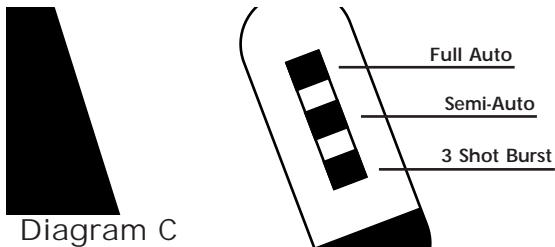

Diagram C

To adjust the rate of fire in the full-auto and 3-shot modes; use a small screwdriver to turn the trimpot clockwise or counter clockwise. Turning the trimpot clockwise will increase the rate of fire. Do not over turn. If the rate of fire has increased beyond the cycling rate of the mechanical portion of the paintball marker, adjust the trimpot counterclockwise to decrease the rate of fire.

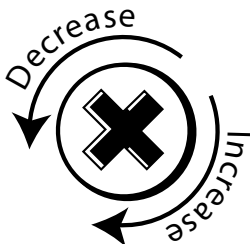

Diagram D

The LED indicator will flash for each firing of the paintball marker. If the LED indicator light does not flash, or it does flash but the paintball marker does not fire, consult the troubleshooting guide in this manual.

BATTERY LIFE

The circuit board in your Rainmaker has a sleep-mode which allows for increased battery life. When the paintball marker is not used for approximately 5 minutes, the circuit board will "shut-down" and not continue to drain the battery. Your battery should last approximately 4 weeks or longer depending on usage. However, it is highly recommended that you remove the battery from the paintball marker during storage. Check the freshness of the battery frequently and replace as necessary.

TROUBLE-SHOOTING GUIDE

NOTE: Refer to the exploded diagram/parts list included with your purchase.

I. GAS LEAKS OUT THE BARREL

1. When you first gas up you may hear a leak, fire the paintball marker once or twice and it should seal up. After playing, if the paintball marker is laid down after taking the tank off, it may make a hissing sound, which is the solenoid valve releasing any back pressure. This is normal, but should only occur for a short period of time. If it continues, see section III below.
2. Valve seal located on the valve stem assembly could cause a leak. A damaged valve body (scratches on the "seat" surface) could cause a leak. The o-ring on valve body could also be cut.
3. Inspect regulator piston, and make sure regulator piston o-ring is okay. Check for trash or debris on regulator seat seal by removing the regulator seat. This requires a special tool similar to a flat-blade screwdriver with a notch cut out of the middle. If the leak is still coming from this area, try replacing the entire regulator housing.
4. If leak continues change out the receiver assembly.
5. Gas pressure is too low for the paintball marker to operate. The Rainmaker will achieve 300 fps using approximately 650-700 psi.

II. PAINTBALL MARKER IS LEAKING OUT THE BACK

1. If leak is coming from hole in the regulator spring cover, replace the regulator piston o-ring.
2. If leaking where the regulator housing mates with the receiver, check the o-ring on the regulator housing. LUBE ALL o-rings before replacing or you will cut the o-rings.

III. PAINTBALL MARKER SLOWLY LEAKS

FROM INSIDE THE FOREGRIP—Four-way solenoid valve or the air cylinder exhaust valves are leaking slowly

1. Solenoid valve will only operate at 100 psi. Anything over 120 psi will cause a leak. If leak occurs at the solenoid valve, replace the low pressure regulator, piston seal, and spring. Lubricate piston o-rings when re-assembling.
2. If leaking from the "A" port of the solenoid or the corresponding exhaust valve from the air cylinder, replace with the silver or brass portion of a new solenoid valve assembly. Remove this part from the black solenoid part by loosening the two small phillips-head screws and just replace this part on your paintball marker.

IV. FAST LEAK FROM INSIDE THE FOREGRIP—

Caused by the hose bursting due to high output pressure from the low pressure regulator.

1. Solenoid valve will only operate at 100 psi. Anything over 120 psi will cause a leak. If leak occurs at the solenoid valve, replace the low pressure regulator piston, piston seal, spring, and hose (long hose). Lubricate piston o-rings when re-assembling.

V. LOW VELOCITY OR NOT ABLE TO ADJUST VELOCITY

1. Gas pressure is too low for the paintball marker to operate. The Rainmaker will achieve 300 fps using approximately 650-700 psi.



2. Velocity-adjustment screw backed out too far or screwed too far in.
3. If you can't get any higher than 250 to 270, replace valve spring with new one or modify original spring by cutting 1 full turn with cutters.
4. Washers in back of paintball marker must be alternating "concave" and "convex" and must have 5 sets. (see diagram)

VI. VELOCITY IS VERY LOW

1. Hammer spring needs replacing. You should get around 50,000 shots from the original hammer spring. Replace the hammer spring with a new one.
2. Valve seal has separated from valve stem. Replace with a new valve stem assembly.

VII. CAN'T GET VELOCITY DOWN BELOW 300 FPS

1. Put spacer (dime or small washer) between valve spring and valve seal stem.
2. Regulator retainer is loose or seat seal is dirty. Replace entire retainer and seal or replace entire regulator housing assembly.

VIII. PAINTBALL MARKER IS CLICKING BUT IT WON'T

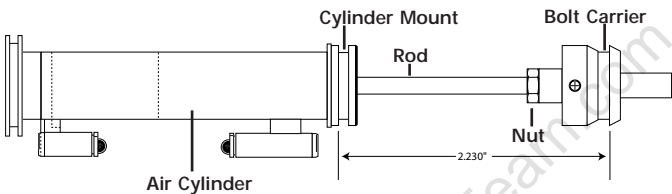

FIRE

1. Low power from batteries. Replace with fresh alkaline battery.
2. A low-pressure hose is pinched. Remove fore-grip cover and inspect.
3. The cylinder mount has to be flush with receiver. The screw on receiver must be tight.
4. Inspect bolt carrier on rod-end of air cylinder and jam nut (behind bolt carrier). If jam nut has loosened, then re-tighten. Check the dimension shown below.

IX. NOTHING HAPPENS WHEN I PULL THE TRIGGER

1. Check the electronics: With gas off the paintball marker, and a

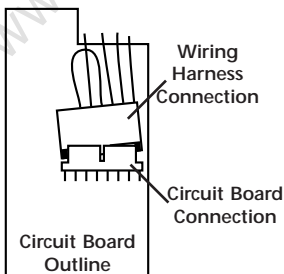

Diagram A
(Improperly Connected)

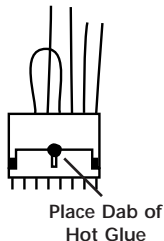
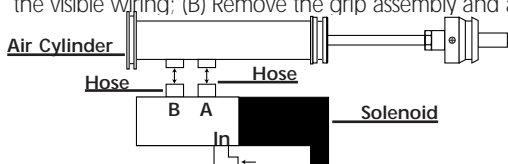

Diagram B
(Properly Re-connected)

fresh battery installed, pull the trigger. You should hear a clicking sound coming from inside the fore-grip cover (hold it up to your ear) and LED light should flash. If you don't hear a clicking sound and LED doesn't flash: (A) Check for pinched or cut electrical wiring by removing the foregrip cover and inspecting the visible wiring; (B) Remove the grip assembly and access the



circuit board. Check the connection between the wiring harness and the circuit board. If loose, reconnect and place a dab of hot glue between the two connectors. (See diagrams below)

X. EVERYTHING IS WORKING ELECTRONICALLY, STILL NOTHING HAPPENS

1. The hoses coming from the solenoid valve may be switched. Remove fore-grip cover and switch hoses or check for pinched hoses. (See diagram below for proper connection)

XI. EXCESSIVE BALL BREAKAGE BEFORE THE BALL GETS IN THE BARREL—

Caused by excessive blow-back from a gap between the front bolt o-ring and the upper rec.

1. Take bolt off. Remove o-rings. Cut a piece of electrical tape the same width as the o-ring groove. Use the tape to wrap one full turn inside the groove. Replace the o-rings. Put the bolt back in place.
2. Ball stop wire may be too far in. Using needle-nose pliers, move or bend wire gently to adjust.

XII. WON'T FEED BALLS

1. Ball feed port is loose or twisted. Replace with new upper receiver or use Loctite 326 and re-assemble back in place.
2. Excess Loctite could be preventing bolt to move forward. Remove excess Loctite from inside of the upper Receiver.

XIII. DOUBLE FEEDING PAINTBALLS

1. Ball stop wire is too far out. Take needle-nose pliers and squeeze the wire together until the marker only feeds on paintball.

XIV. GAS LEAKS FROM BOTTLE CONNECTION

1. The bottle o-ring is damaged. Replace o-ring. (See diagram)

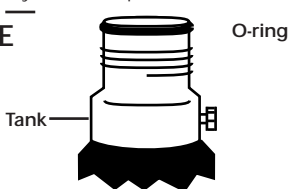



(Correspondence Only)

1203A North 6th St., Rogers, Ar 72756 U.S.A.

(501)986-9090 Fax (501)986-6666

Brass Eagle[®]

P.O. Box 1956

Rogers, AR 72757, U.S.A.

www.brasseagle.com

Made In U.S.A.

Part No. 130123-000

 **Brass Eagle**[®]
PAINTBALL PRODUCTS

Kainmaker[™]

by  **Brass Eagle**[®]



THIS BOOKLET CONTAINS:

- Safety Information
- Warranty Information
- Annotated Diagram
- Operating Instructions
- Select-Fire Instructions
- Battery Life Information
- Trouble-Shooting Guide

MODEL 1451 OWNER'S MANUAL
.68 CALIBER ELECTRONICALLY ACTIVATED
ULTRA-PREMIUM SELECT-FIRE PAINTBALL MARKER

NOT INTENDED FOR SALE TO PERSONS UNDER AGE 18



WARNING: THIS IS NOT A TOY. MISUSE MAY CAUSE SERIOUS INJURY OR DEATH. EYE PROTECTION DESIGNED FOR PAINTBALL USE MUST BE WORN BY THE USER AND ANY PERSON WITHIN RANGE. RECOMMEND AT LEAST 18 YEARS OLD TO PURCHASE, 14 YEARS OLD TO USE WITH ADULT SUPERVISION, OR 10 YEARS OLD TO USE ON PAINTBALL FIELDS MEETING ASTM-STANDARD F1777-97. READ OPERATION MANUAL BEFORE USING.

SPANISH OPERATION MANUAL 00-00
FRENCH OPERATION MANUAL 00-00